

Weldless Steel Tank 160 Liter Type A (42,3 Gallon)

mm [in]

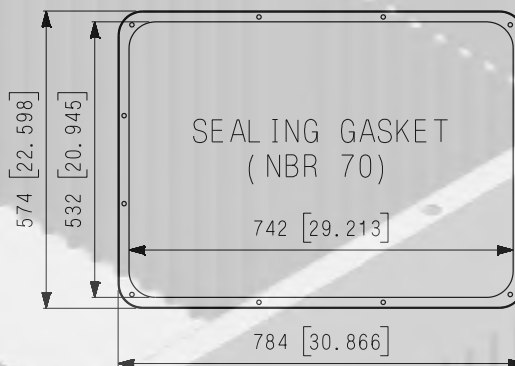

Lid 160 Liter (42,3 Gallon)

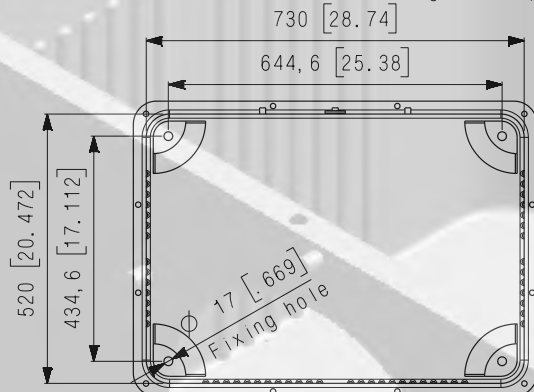
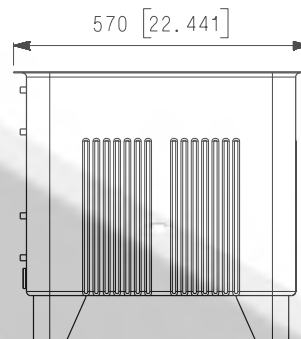
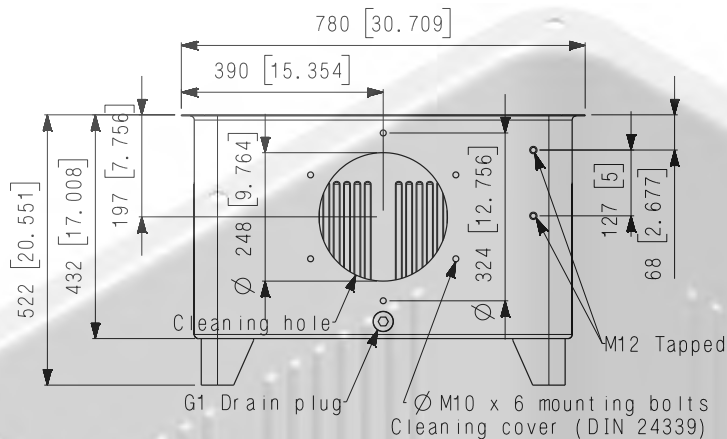
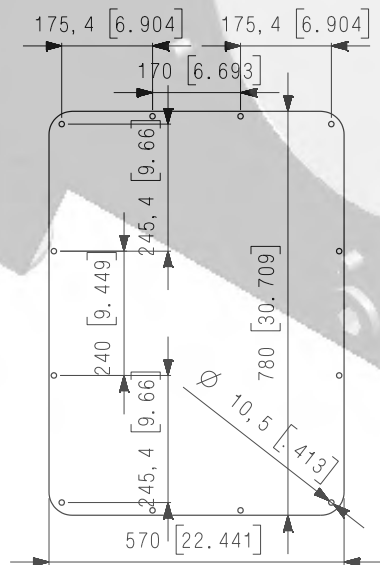

Style A Lid plate
Blank Lid

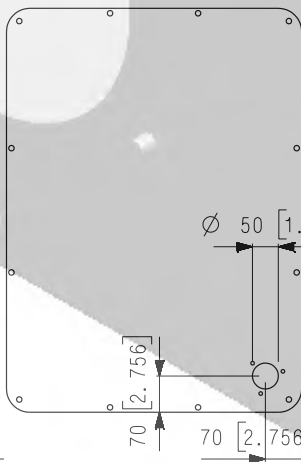

Style B Lid plate
with
Filler Breather (FB)
cutout Lid

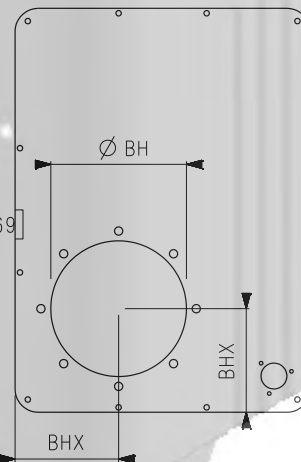

Style C Lid plate
with
Filler Breather (FB) and
Bellhousing (BH)
cutout Lid

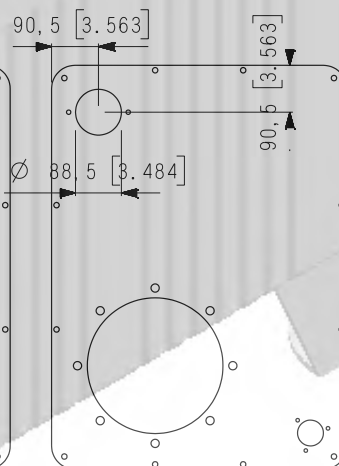

Style D Lid plate
with
Filler Breather (FB),
Bellhousing (BH) and
Return Filter (RF)
cutout Lid



Weldless Steel Tank 160 Liter Type B (42,3 Gallon)

mm [in]

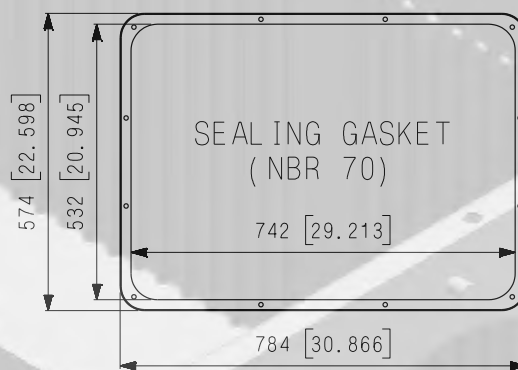
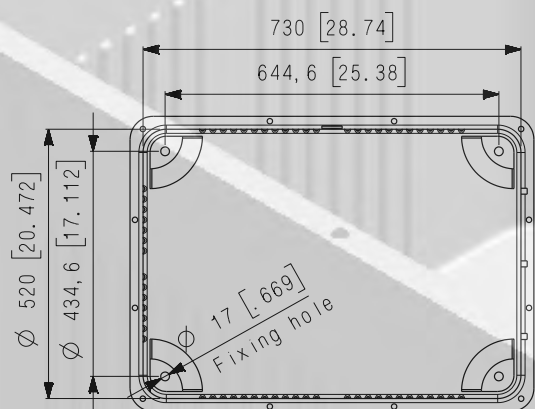
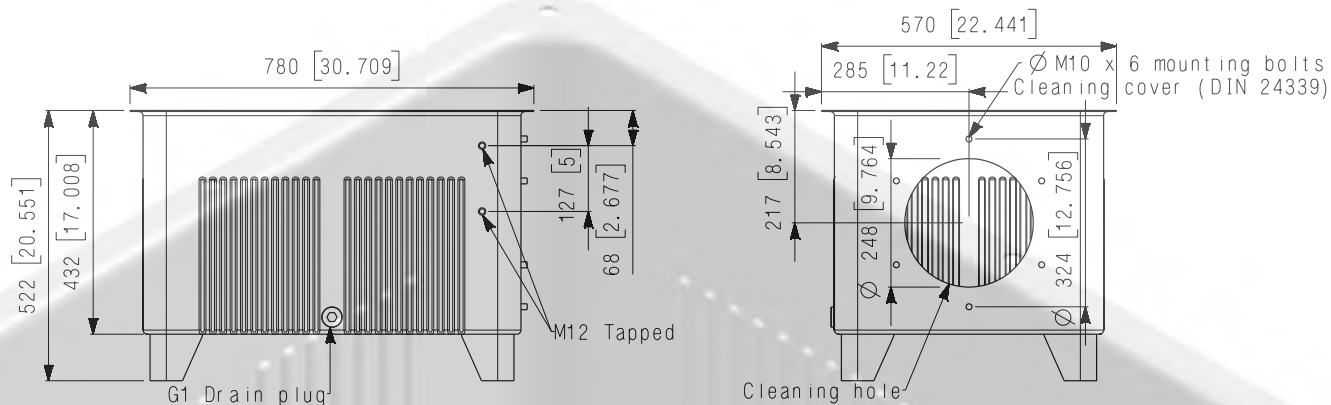

Lid 160 Liter (42,3 Gallon)

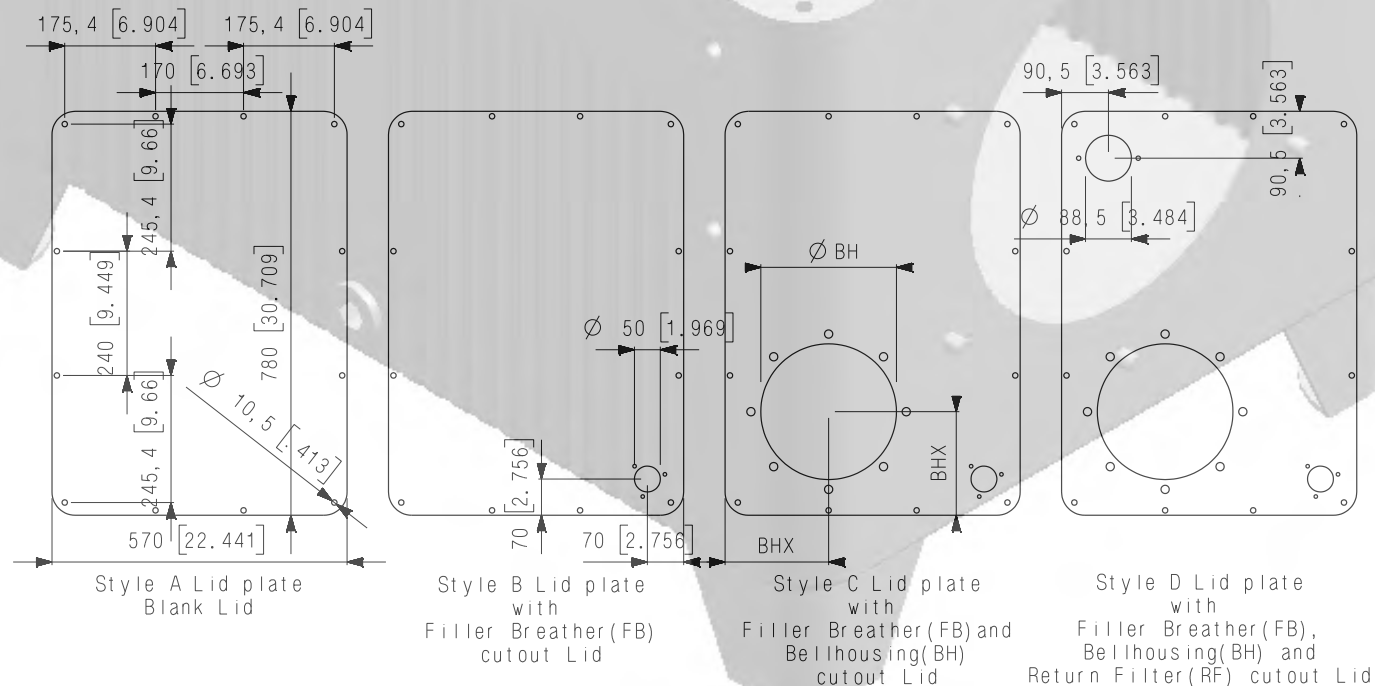

Weldless Steel Tank 160 Liter Type C (42,3 Gallon)

mm [in]

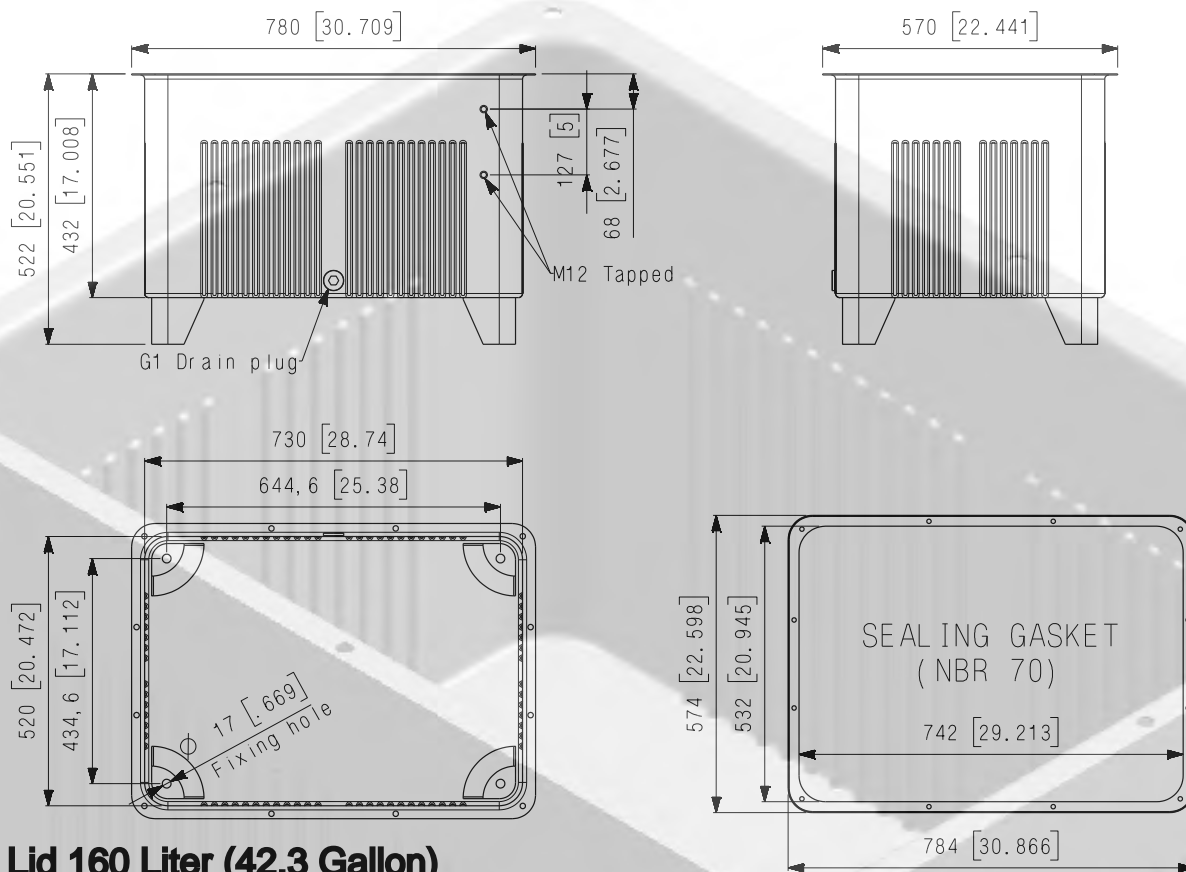

Lid 160 Liter (42,3 Gallon)

